

ROOF WITH OPEN SOFFET MOUNTING REQUIREMENTS FOR VARIOUS AWNING LENGTHS

AWNING ASSEMBLY W/ BRACKET MOUNTS

3/8" x 4" HEX LAG BOLT & FLAT WASHER
TYPICAL HARDWARE FOR
ROOF MOUNT PANEL

LAG BOLT CAP, TYP.

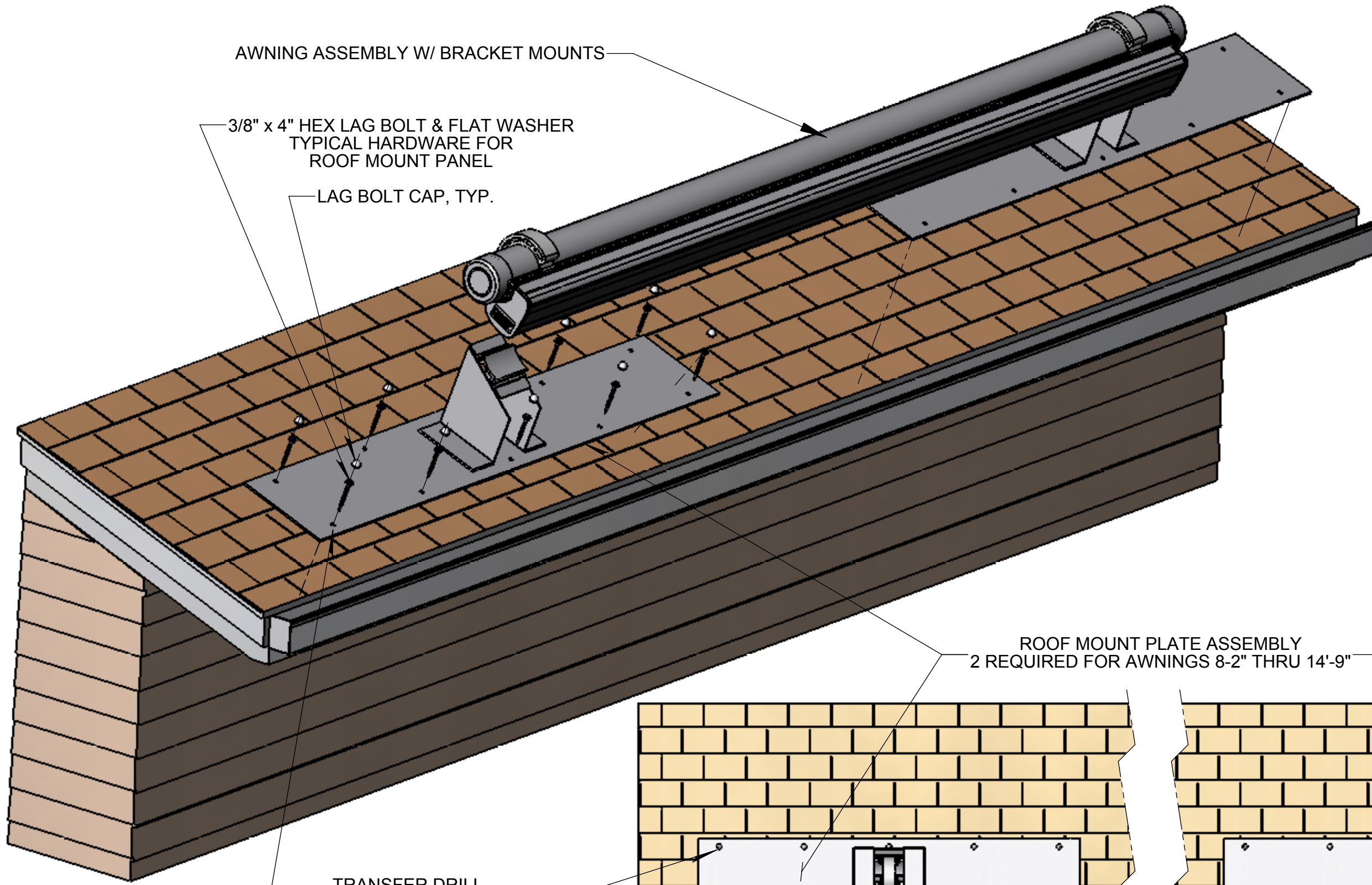

0-6 ROOF MOUNT CONFIGURATION

TUBE MOUNT

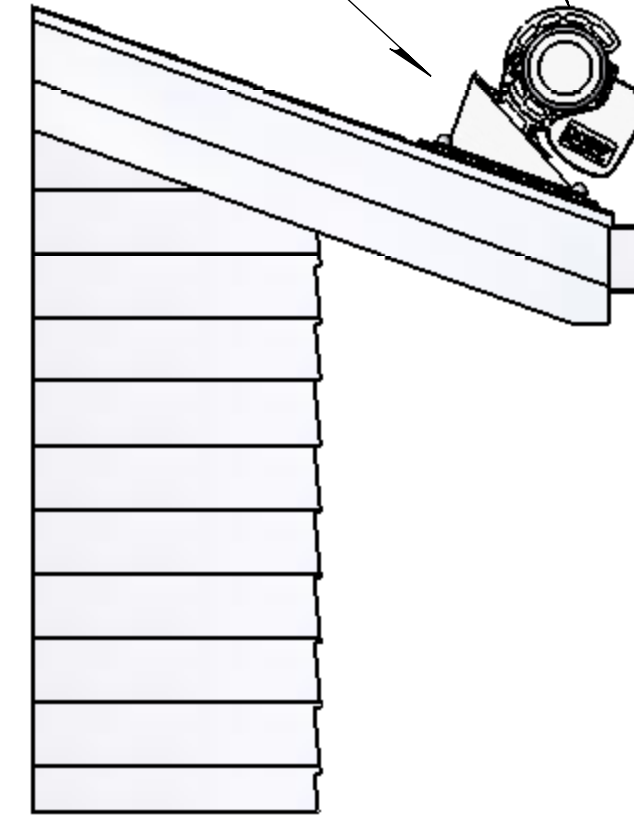

6-12 ROOF MOUNT CONFIGURATION

ASPHALT
ROOFING

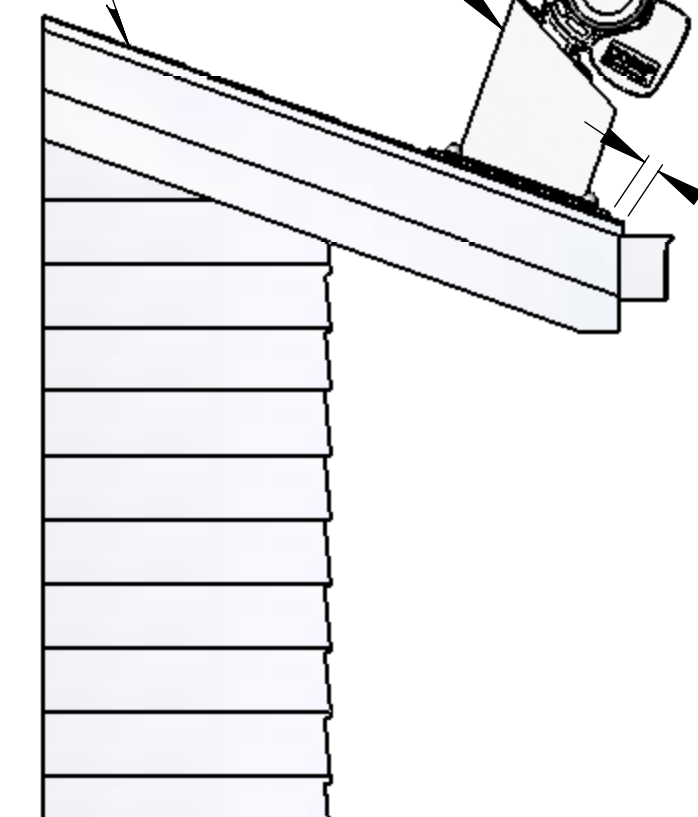

1" - 2" TYP.

ROOF MOUNT PLATE ASSEMBLY
2 REQUIRED FOR AWNINGS 8'-2" THRU 14'-9"

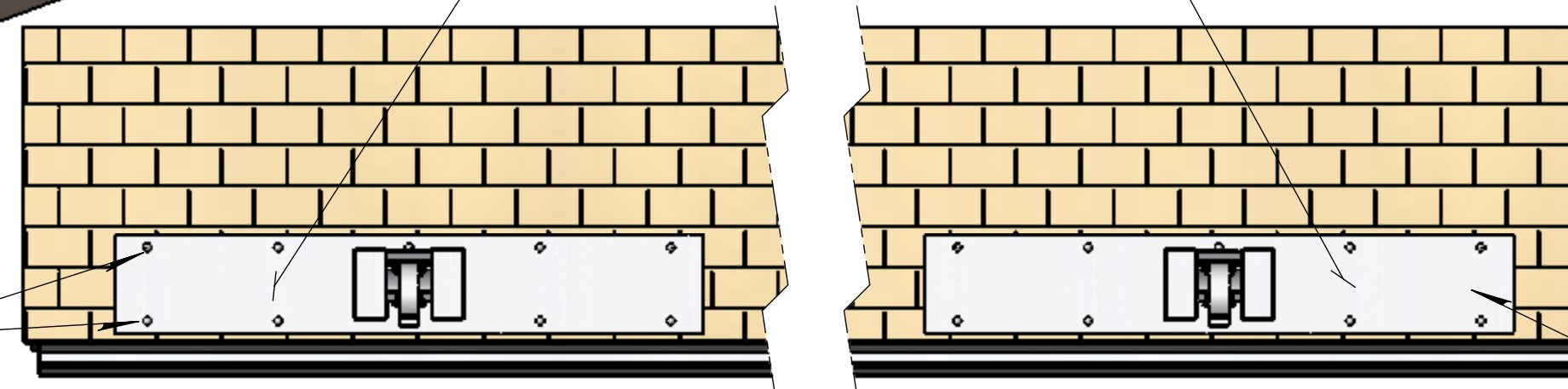

TRANSFER DRILL
FROM ROOFMOUNT
TO ROOF RAFTER/TRUSS

16" TYP.

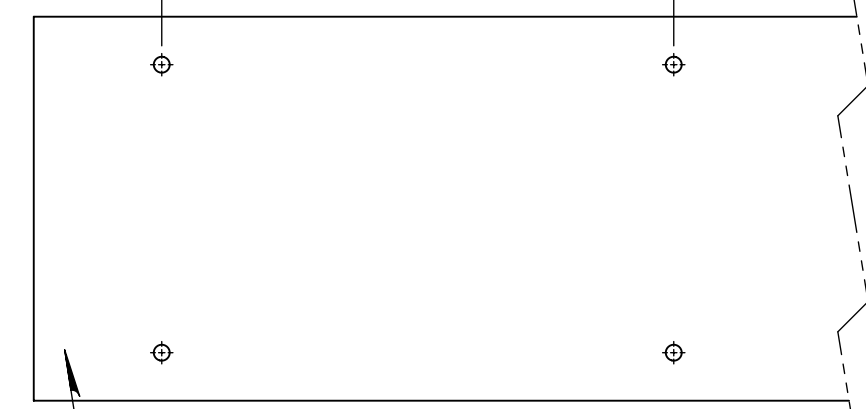

ROOF MOUNT PLATE SECTION A-A
TYP.

ROOF MOUNT PLATE ASSEMBLY
3 REQUIRED FOR AWNINGS 16'-5" THRU 23'

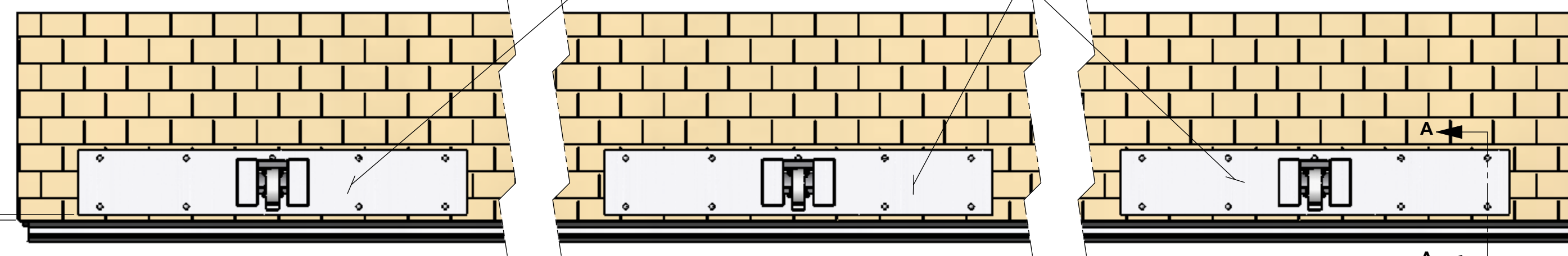

1" - 2" TYP.

ROOF PLATE

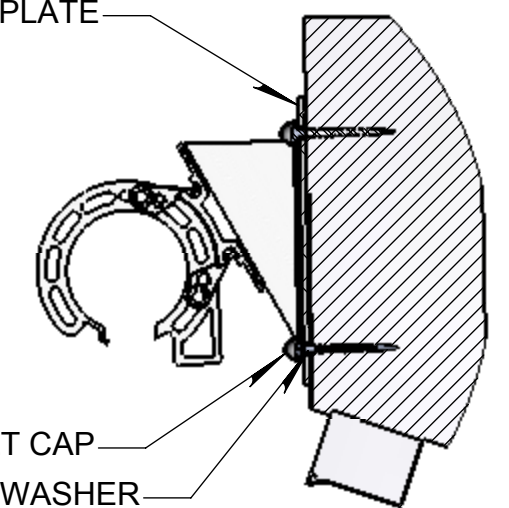

LAG BOLT CAP
3/8" x 4" HEX LAG BOLT & FLAT WASHER

ROOF MOUNT PLATE ASSEMBLY
4 - 5 REQUIRED FOR AWNINGS 24'-6" THRU 32'-9"

